

## Syllabus of Tender

### Self Supported 80 ft four legged Tower

Bid Reference: **RS-2(t-ins)/2010**

Date: **Dehradun: Oct. 14 ,2010**

<b>Sl.No.</b>	<b>Syllabus of Tender</b>	<b>Chapters</b>	<b>Page No.</b>
1.	Bid reference.	Chapter 1 <sup>st</sup>	01
2.	Instruction for Bidders. Conditions of contract and restrictions.	Chapter 2 <sup>nd</sup>	02
3.	Details of demand of goods/services.	Chapter 3 <sup>rd</sup>	06
4.	Specifications and allied technical details.	Chapter 4 <sup>th</sup>	07
5.	Price Schedule( to be utilized by the bidders for quoting their prices)	Chapter 5 <sup>th</sup>	10
6.	Format/Pro-forma of contract/Agreement.	Chapter 6 <sup>th</sup>	11
7.	Other standard forms & guidelines for bidders.	Chapter 7 <sup>th</sup>	12
8.	Check list for Bidders	Chapter 8 <sup>th</sup>	34

## Chapter 1<sup>st</sup>

**Govt. of Uttarakhand  
Office of Director General of Police  
Police Headquarters, Uttarakhand  
12, Subhas Marg, Dehradun.**

**Ph.No. 0135-2712685/2735141  
Fax No.0135-2712080/ 2733127  
Web Site:-[www.Uttarakhandpolice.com](http://www.Uttarakhandpolice.com)**

**Tender No.RS-2(t-ins)/2010**

**Date: Dehradun: Oct. 14 ,2010**

On behalf of the Governor of Uttarakhand tender is invited in duplicate for the supply/installation of Self Supported 80 ft four legged Tower for the police Department of Uttarakhand.

**NOTE:-** Tender is restricted to **actual manufacturing companies only**. Documentary proof, duly attested in support of being a manufacturing company, must be submitted along with the tender form. The tendering firms are requested to submit their **sealed offer in two parts: "Technical Bid" and "Financial Bid"**. The technical offer and financial offer are to be submitted simultaneously in two separate sealed envelopes clearly super scribed '**Technical Bid**' and '**Financial Bid**' in bold letters. Tender no., date and purpose of the tender should also be mentioned clearly on the top of the outer cover. In financial offer, the bid amount should also be written in words also.

- 
- 1. Last date for receipt of tender : Oct 27, 2010 upto 1600 hrs**
  - 2. Opening of Technical Offer : Oct 28, 2010 from 1600 hrs**
  - 3. Opening of Financial Offer : Oct 29, 2010 from 1600 hrs**

---

(Tender document may be obtained/submitted at Police Sanchar bhawan Jakhn, Dehradun on any working day.)

Tenderers should note if the date of tender opening (or date upto which offer is to remain open) is declared a closed holiday by the Govt., the tender shall be opened on the next working date (Offer shall remain open for acceptance till the next working day).

---

## Chapter 2<sup>nd</sup>

**4. Tender Fee:** Tender forms can be obtained from the Police Sanchar Bhawan Jakhan Uttarakhand, Dehradun on payment of tender fee **Rs. 265/- ( Tender Fee +12.5% vat )** by cash or in **D.D. in favour of I.G. (PHQ), Dehradun** on all working days between 1000 hrs to 1700. Tender form downloaded from Uttarakhand Police website will also be allowed. In this condition, D.D. of tender fee should be attached with technical bid.

**5. Specification:** Detailed specifications can be obtained from Police Sanchar Bhawan Jakhan, Dehradun. Specification will also be placed on our website.

**6. Validity of offer** - 90 days.

**7. Financial Offer:** Tendering firms are required to quote Total rate with all taxes & installation charges with service tax separately. Rates should be quoted **F.O.R. Police Station Risikesh Distt Dehradun**. The rate should be written in the prescribed form given with Tender Form.

**8. Delivery Period:** (i) The supply of stores is required to be made within stipulated time from the date of Purchase Order. If supply is not given within stipulated time, then @ of 1 % penalty would be imposed for the next three days and so on up-to maximum 15 days. After that purchase order will be cancelled.

(ii) Unless the last date for supply of stores is specifically extended by the purchaser, the supply order is liable to be cancelled after the expiry of stipulated period without any liability on the part of the Police technical Headquarters, In case, the tenderer experiences some genuine problem in supplying the stores with in the stipulated period, they are advised to promptly seek extension of delivery period, which may be allowed at the sole discretion of the purchaser.

**10. Earnest Money:** All Tendering firms are required to submit Earnest Money **Rs.16000/-** in the form of F.D.R./ B.D. (valid for not less than six months) pledged to **I.G. PHQ Uttarakhand, Dehradun**. Earnest money shall be submitted along with the technical bid.

**11.** The submitting of the tender by post is not acceptable.

**12.** Tenders presented not as per the terms and conditions shall be rejected.

### **13. Inspection:**

i) The Purchaser shall have the right to inspect and/or test the goods for conformity to the Contract Specifications. And any goods failing to confirm specifications can be rejected.

ii) A document comprising of the technical problems faced during installation, testing and commissioning period and their solutions shall be submitted by the Supplier at the time of handing over the completed works ( installed Tower ) to ARO/RI Dehradun.

iii) The installation or commissioning shall not be deemed to have been completed unless all the equipment and System are accepted by the Purchaser.

### **14. Payment Schedule:**

The Purchaser shall pay, to the Supplier, hundred percent (100%) payment, after

successful installation of the Tower at the site and satisfactory report of user.

**15.** The tenderer will specify after-sales service and support mechanism clearly in the bid. Frequency of routine maintenance during warranty period and breakdown maintenance should also be clearly specified.

**16.** Liquidated damages may be imposed for defaults/inordinate delays on the part of the supplier who is also liable to be blacklisted.

**17. Guarantee/ Warranty**

i)The Supplier shall provide comprehensive on-site Guarantee/ Warranty for item supplied under the Contract at least for a period of 3 (three) years from the date of final acceptance of the System. Supplier also quoted rates per year separately for 5 yrs AMC after expiry of Guarantee/ Warranty period.

ii)If the performance of any individual equipment or System fails to meet the contract specifications then the same shall be replaced by the Supplier free of cost during the term of the warranty/guarantee period.

iii)The maintenance services, including spares shall be free of cost during the warranty/guarantee period.

ix)If the Supplier fails to repair or replace the defective Equipment/ Item, the Purchaser will be free to get the same repaired/replaced from the market and its cost will be adjusted from the Supplier's Contract Performance Security.

**18. Past performance: Tendering firms are required to give their past performance with certificate of concern department. It is compulsory parts of the technical bids.**

**19. Security Money** to the tune of 10% of the total cost of stores shall be submitted in the form of Demand Draft/FDR pledged in favour of IG (Hqrs) within 10 days from the date of issue of supply order. This will be released after successful completion of Warrantee Period of works.

**20.** Tenderers are required to submit valid Trade Tax Registration No. & PAN Account and their Clearance Certificate along with the technical offer.

**21.** The tenderers are required to enclose self-addressed registered stamped envelope along with their technical offer.

**22. Site Preparation**

Supplier will make a visit of site before submitting tender document

i)The site for installation of the System shall be provided by the Purchaser as per the required environmental conditions before the installation of the system.

ii)The Supplier shall provide site plan and equipment layout plan for the System.

iii)The complete installation of the system at the Purchaser's site shall be the responsibility of the Supplier.

iv)The item is to be installed at the locations Police Station Risikesh Distt. Dehradun.

v) Earthing /Aviation light arrangements for all the Equipment shall be the responsibility of the Supplier and to be carried out as per standard procedures.

**23. Responsibility of Completion:** Any fittings or items which may not be specially

mentioned in the specifications but which are necessary are to be provided by the Supplier without any extra charge for completeness of the work under this Tender.

**24. Patent/Proprietary Rights:** The Supplier shall indemnify the Purchaser against all third party claims of infringement of patent, copyright, trademark, license or industrial design rights, software piracy arising from use of the goods or any part thereof in the Purchaser's country.

**25. Severability:** If any portion of this Contract or any of the Contract Documents hereto is held to be invalid, such provision shall be considered severable, and the remainder of this Contract hereof shall not be affected.

**26.** Tenderers are advised to go carefully through the tender conditions and instructions and ensure compliance before submitting their tender. Conditions other than those mentioned in the tender notice shall not ordinarily be acceptable and such offers may be ignored.

**27.** No representation shall be accepted after opening of financial offer.

**28.** The successful bidder whose offer is accepted shall have to execute an agreement on a Non-Judicial stamp paper of Rs.100/- within 10 days of the receipt of written order

**Special Conditions:-**

**29.** All the tendering firms are advised to give Name & Designation of the person signing the tender form.

**30.** The Director General of Police Uttarakhand may increase upto 50% or decrease upto 25% of total quantity to be purchased.

**31.** The Director General of Police Uttarakhand is empowered to accept or reject the tender at any stage without assigning any reason.

**32. Governing Law:** This Contract including the Contract Documents shall be governed by and construed in accordance with the laws of India and the Dehradun Courts shall have jurisdiction in this regard.

**Dy. Inspr. General (Police Telecom)  
Uttarakhand Police  
Dehradun.**

Chapter 3<sup>rd</sup>

Sl. No.	Name of article	Quantity
1.	<b>80 feet four legged self supported hot dip galvanized Tower complete with Installation. foundation, earthing, lightening arrestor, photo syntheses swathing aviation warning light etc. (as per drawing &amp; specs enclosed) at Police Station Risikesh</b>	<b>1 Sets</b>

## Chapter 4<sup>th</sup>

### **SPECIFICATIONS OF 80 FEET SELF SUPPORTED TOWER**

Sl No.	Specifications	Details
1	Cross-Section	Square
2	Base Width	3375 mm $\pm$ 3%
3	Top Width	1000 mm $\pm$ 3%
4	Wind velocity handling capacity	180 KMPH
5	Material	
	(a) Legs and Bracing etc	MS angle as per IS-326 sizes are as given in drawing
	(b) Hardware	High tensile nuts/bolts as per IS-1364 Ordinary nuts/bolts as per IS-1363
6	Weight of the Tower	2500 KG $\pm$ 3%
7	Finish	Hot Dip Galvanized
8	Ladder facility internal	Provided with safety rings around ladder from 5 mtr height
9	Platform	provided
10	Earth wire	provided
11	Aviation Light (Twin)	provided
12	Lightening arrestor	provided
13	Top Load	250 KGS
14	Factor of safety	4
15	Sundown photo switch	provided

FOUNDATION DIAGRAM  
OF  
80 FEET SELF SUPPORTED TOWER

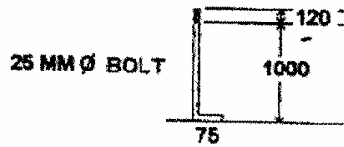
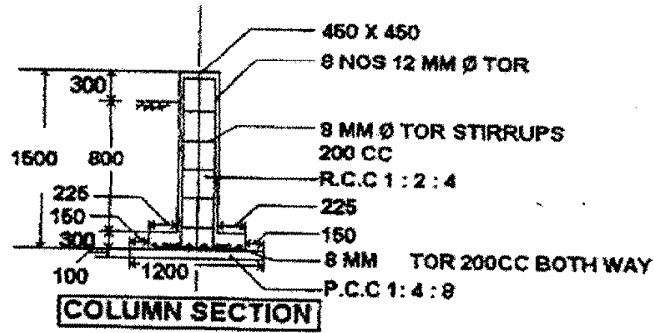
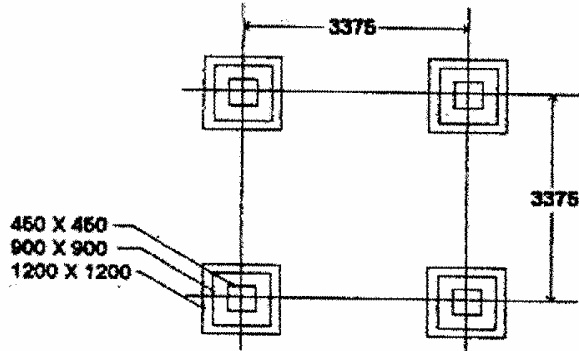

**BASE BOLTS**

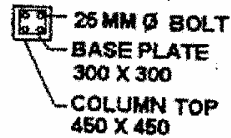

**BASE PLATE**

**ALL DIMENSIONS IN MM**

SELF SUPPORTED TOWER 80 FEET (24M)

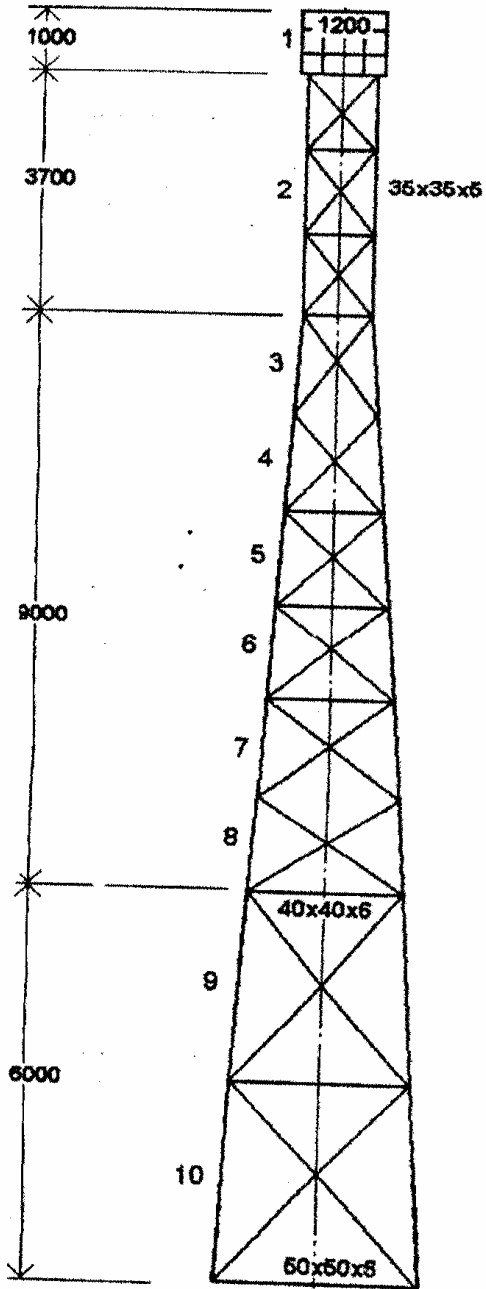

PARTICULARS OF PANEL FRAME VERTICAL FROM TOP TO BOTTOM		
SER. NO.	SIZE	HEIGHT
1.	65 X 65 X 6	0 TO 12.0 M
2.	75 X 75 X 8	12.0 TO 20.0 M
3.	90 X 90 X 8	20.0 TO 24.0 M

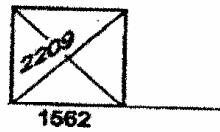

ANGLE	BOLTS
35 X 35 X 6	12 $\phi$ BOLTS
40 X 40 X 8	16 $\phi$ BOLTS
50 X 50 X 8	16 $\phi$ BOLTS

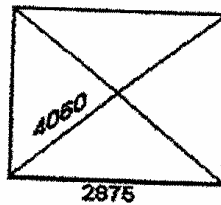



## Chapter 6<sup>th</sup>

### CONTRACT FORM

THIS AGREEMENT made the .....day of....., 20... Between..... (Name of purchaser) of ..... (Country of Purchaser) (Hereinafter called "the Purchaser") of the one part and ..... (Name of Supplier) of ..... (City and Country of Supplier) (Hereinafter called "the Supplier") of the other part : WHEREAS the Purchaser is desirous that certain Goods and ancillary services viz., ..... (Brief Description of Goods and Services) and has accepted a bid by the Supplier for the supply of those goods and services in the sum of ..... (Contract Price in Words and Figures) (Hereinafter called "the Contract Price").

NOW THIS AGREEMENT WITNESSETH AS FOLLOWS:

1. In this Agreement words and expressions shall have the same meanings as are respectively assigned to them in the Conditions of Contract referred to.
  2. The following documents shall be deemed to form and be read and construed as part of this Agreement, viz.:
    - (a) The Bid Form and the Price Schedule submitted by the Bidder;
    - (b) The Schedule of Requirements;
    - (c) The Technical Specifications;
    - (d) The General Conditions of Contract and restrictions;
    - (e) The Special Conditions of Contract; and
    - (f) The Purchaser's Notification of Award.
  3. In consideration of the payments to be made by the Purchaser to the Supplier as hereinafter mentioned, the Supplier hereby covenants with the Purchaser to provide the goods and services and to remedy defects therein in conformity in all respects with the provisions of the Contract.
  4. The Purchaser hereby covenants to pay the Supplier in consideration of the provision of the goods and services and the remedying of defects therein, the Contract Price or such other sum as may become payable under the provisions of the Contract at the times and in the manner prescribed by the Contract.
- Brief particulars of the goods and services which shall be supplied/ provided by the Supplier are as under:

SL. NO.	BRIEF DESCRIPTION OF GOODS & SERVICES	QUANTITY TO BE SUPPLIED	UNIT PRICE	TOTAL DELIVERY PRICE	TERMS

**TOTAL VALUE:**

**DELIVERY SCHEDULE:**

**IN WITNESS** whereof the parties hereto have caused this Agreement to be executed in accordance with their respective laws the day and year first above written.

Signed, Sealed and Delivered by the  
said ..... (For the Purchaser)

in the presence of:.....

Signed, Sealed and Delivered by the  
said ..... (For the Supplier)

in the presence of:.....

## Chapter 7<sup>th</sup>

Bid Reference: .....

Director General of Police  
12, A Subhash Road,  
Uttarakhand Police Headquarter  
Dehradun-248001  
(Uttarakhand)

### TENDER DOCUMENT FOR PROCUREMENT OF GOODS

DATE OF COMMENCEMENT OF SALE OF TENDER DOCUMENT :  
LAST DATE FOR SALE OF TENDER DOCUMENT :  
LAST DATE AND TIME FOR RECEIPT OF BIDS :  
TIME AND DATE OF OPENING OF BIDS :

Enclosure-Schedule of Requirement and technical details

#### **INSTRUCTIONS TO BIDDER**

##### **1. Cost of Bidding**

The Bidder shall bear all costs associated with the preparation and submission of its bid, and Office of The Director General, of police , Dehradun Uttarakhand hereinafter referred to as "the Purchaser", will in no case be responsible or liable for these costs, regardless of the conduct or outcome of the bidding process

##### **2. Content of Bidding Documents**

The goods required, bidding procedures and contract terms are prescribed in the bidding documents. In addition to the Invitation for Bids, the bidding documents include:

1. Instruction to Bidders (ITB) ;
2. General Conditions of Contract (GCC) and Restrictions
3. Schedule of Requirements(details of demands of goods, consignees ,services, etc..)
4. Technical Specifications;
5. Bid Form;
6. Price Schedules;
7. Bid Security Form;
8. Contract Form;
9. Performance Security Form;
10. Performance Statement Form;
11. Manufacturer's Authorization Form;
12. Performance Security Form for CMC;

The Bidder is expected to examine all instructions, forms, terms, and specifications in the bidding documents. Failure to furnish all information required by the bidding documents or submission of a bid not substantially responsive to the bidding documents in every respect will be at the Bidder's risk and may result in rejection of its bid.

##### **3. Clarification of Bidding Documents**

A prospective Bidder requiring any clarification of the bidding documents may notify the Purchaser in writing or by telex or email or fax at the Purchaser's mailing address indicated in the Invitation for Bids. The Purchaser will respond in writing to any request for clarification of the bidding documents which it receives no later than 15 days prior to the deadline for submission of bids prescribed by the Purchaser. Written copies of the Purchaser's response (including an explanation of the query but without identifying the source of inquiry) will be sent to all prospective bidders which

have received the bidding documents.

#### **4. Amendment of Bidding Documents**

1. At any time prior to the deadline for submission of bids, the Purchaser may, for any reason, whether at its own initiative or in response to a clarification requested by a prospective bidder, modify the bidding documents by amendment.
2. All prospective bidders who have received the bidding documents will be notified of the amendment in writing or by email or by fax, and will be binding on them.
3. In order to allow prospective bidders reasonable time in which to take the amendment into account in preparing their bids, the Purchaser, at its discretion, may extend the deadline for the submission of bids.

#### **5. Language of Bid**

The bid prepared by the Bidder, as well as all correspondence and documents relating to the bid exchanged by the Bidder and the Purchaser shall be written in English language. Supporting documents and printed literature furnished by the Bidder may be in Hindi provided they are accompanied by an accurate translation of the relevant passages in the English language in which case, for purposes of interpretation of the Bid, the translation shall govern.

#### **6. Documents Constituting the Bid**

The bid prepared by the Bidder shall comprise all the documents according to bid document.

#### **7. Bid Form**

The Bidder shall enclose the complete furnished Bid Form and the appropriate Price Schedule furnished in the bidding documents, indicating the goods to be supplied, a brief description of the goods, and their country of origin, quantity and prices.

#### **8. Bid Prices**

The Bidder shall indicate on the Price Schedule the unit prices and total bid prices of the goods it proposes to supply under the Contract. Bidders shall quote for the complete requirement of goods and services specified under each schedule on a single responsibility basis, failing which such bids shall not be taken into account for evaluation and shall not be considered for award. Bidder should quote the cost of Comprehensive Maintenance Service a period of 04 years on a yearly basis, after expiry of the 3 (Three) years Warranty period. Fixed Price. Prices quoted by the Bidder shall be fixed during the Bidder's performance of the Contract and not subject to variation on any account. A bid submitted with an adjustable price quotation will be treated as non-responsive and rejected.

#### **9. Documents Establishing Bidder's Eligibility and Qualifications**

1. The Bidder shall furnish, as part of its bid, documents establishing the Bidder's eligibility to bid and its qualifications to perform the Contract if its bid is accepted.
2. The documentary evidence of the Bidder's eligibility to bid shall establish to the Purchaser's satisfaction, at the time of submission of its bid.
3. The documentary evidence of the Bidder's qualifications to perform the Contract if its bid is accepted, shall establish to the Purchaser's satisfaction:
  - (a) that, in the case of a Bidder offering to supply goods under the contract which the Bidder did not manufacture or otherwise produce, the Bidder has to enclose the authorization, been duly authorized (as per authorization form ) by the goods' Manufacturer or producer to supply the goods in India,.[Note: Supplies for any particular item in each schedule of the bid should be from one manufacturer only. Bids from agents offering supplies from different manufacturers for the same item of the schedule in the bid will be treated as non-responsive.]
  - (b) That the Bidder has the financial, technical, and production capability necessary to perform the Contract and meets the criteria outlined in the Qualification requirements to this end, all bids submitted shall include the following information:
    - (i) The legal status, Industrial Registration/Municipal Registration for factory license/Companies act Registration and principal place of business of the company or firm or partnership, etc.;
    - (ii) Details of experience and past performance of the bidder on equipment offered and on those of similar nature within the past three years and details of current contracts in hand and other commitments (suggested Performa given in the bid document);

#### **10. Documents Establishing Goods' Eligibility and Conformity to Bidding Documents**

1. The Bidder shall furnish, as part of its bid, documents establishing the eligibility and conformity to the bidding documents of all goods and services which the Bidder proposes to supply under the contract.
2. The documentary evidence of conformity of the goods and services to the bidding documents may be in the form of literature, drawings and data, and shall consist of :
  - (a) a detailed description of the essential technical and performance characteristics of the goods ;
  - (b) a list giving full particulars, necessary for the proper and continuing functioning of the goods , following commencement of the use of the goods by the Purchaser; and

(c) an item-by-item commentary on the Purchaser's Technical Specifications demonstrating substantial responsiveness of the goods and services to those specifications or a statement of deviations and exceptions to the provisions of the Technical Specifications.

(d) For purposes of the commentary, the Bidder shall note that standards for workmanship, material and equipment, and references to brand names or catalogue numbers designated by the Purchaser in its Technical Specifications are intended to be descriptive only and not restrictive. The Bidder may substitute alternative standards, brand names and/or catalogue numbers in its bid, provided that it demonstrates to the Purchaser's satisfaction that the substitutions ensure substantial equivalence to those designated in the Technical Specifications.

#### **11. Bid Security/Earnest Money Deposit**

The Bidder shall furnish, as part of its bid, a bid security/ Earnest Money Deposit in the amount as specified.

1. The bid security/ Earnest Money Deposit is required to protect the Purchaser against the risk of Bidder's conduct which would warrant the security's forfeiture.
2. The bid security/ Earnest Money Deposit shall be denominated in Indian Rupees and shall:
3. at the bidder's option, be in the form of a demand draft, bank guarantee from a nationalized/Scheduled Bank located in India in favor of Inspector General, of Police (HQ) and be submitted to Deputy Inspector General, of Police (P/T) jorhi gaon road, Jakhan, Dehradun, (Uttarakhand) in its original form; copies will not be accepted; and remain valid for a period of 45 days beyond the original validity period of bids,
4. Any bid not secured with bid security/ Earnest Money Deposit will be rejected by the Purchaser as non-responsive.
5. Unopened or Unsuccessful bidder's bid securities/ Earnest Money Deposit will be discharged /returned as promptly as possible as but not later than 30 days after the expiration of the period of bid validity prescribed by the Purchaser.
6. The successful Bidder's bid security/ Earnest Money Deposit will be discharged upon the Bidder signing the Contract,, and after furnishing the performance security
7. The bid security/ Earnest Money Deposit may be forfeited:
  - (a) if a Bidder (i) withdraws its bid during the period of bid validity specified by the Bidder on the Bid Form; or
  - (ii) does not accept the correction of errors pursuant to GCC; or
  - (b) in case of a successful Bidder, if the Bidder fails:
    - (i) to sign the Contract in accordance with GCC; or
    - (ii) to furnish performance security in accordance with the terms and conditions..

#### **12. Period of Validity of Bids**

1. Bids shall remain valid for 180 days after the deadline for submission of bids prescribed by the Purchaser,. A bid valid for a shorter period shall be rejected by the Purchaser as non-responsive
2. In exceptional circumstances, the Purchaser may solicit the Bidder's consent to an extension of the period of validity. The request and the responses there to shall be made in writing (or by email or telex or fax). The bid security provided shall also be suitably extended. A Bidder may refuse the request without forfeiting its bid security. A Bidder granting the request will not be required nor permitted to modify its bid.

#### **13. Format and Signing of Bid**

1. The bidder shall prepare two separate bid copies, clearly marking each for Technical Bid and Financial Bid
2. The Bidder shall prepare two separate copies of the technical bid and financial bid, clearly marking each "Original Bid" and "Copy Bid", as appropriate. In the event of any discrepancy between them, the original shall govern.
3. The original and all copies of the bid shall be typed or written in indelible ink and shall be signed by the Bidder or a person or persons duly authorized to bind the Bidder to the Contract. The letter authorization shall be indicated by written power-of-attorney accompanying the bid. All pages of the bid, except for unamended printed literature, shall be initialed by the person or persons signing the bid.
4. Any interlineations, erasures or overwriting shall be valid only if they are initialed by the persons or persons signing the bid.
5. The Bidder shall furnish information as described in the Form of Bid on commissions or gratuities, if any, paid or to be paid to agents relating to this Bid, and to contract execution if the Bidder is awarded the contract.

#### **14. Sealing and Marking of Bids**

1. The Bidders shall seal the original and each copy of the Technical Bid and Financial Bid in separate inner envelopes, duly marking the envelopes as "original" and "copy". He shall then place the original and copy of both in an outer envelope
2. In the technical bid the bidder should not indicate any price details, if there is any price indication of the quoted equipment, the bids will be rejected.
3. The technical bid and the financial bid should be sealed by the bidder in separate covers/ duly super scribed and both those sealed covers will put in a bigger cover which should also be sealed and duly super scribed. The financial bids of only those bidders shall be opened who have qualified in the technical bid for further evaluation in ranking and the remaining financial bids (Envelopes) will not be opened and as such returned to the bidders.

4. The inner envelopes shall also indicate the name and address of the Bidder to enable the bid to be returned unopened in case it is declared "late".
5. If the outer envelope is not sealed and marked the Purchaser will assume no responsibility for the bid's misplacement or premature opening.
6. Telex, email, post or facsimile bids will be rejected.

**15. Deadline for Submission of Bids**

1. Bids must be received by the Purchaser at the address specified (a) no later than the time and date specified in the Invitation for Bids In the event of the specified date for the submission of Bids being declared a holiday for the Purchaser, the Bids will be received on the appointed time on the next working day.
2. The Purchaser may, at its discretion, extend this deadline for submission of bids by amending the bid documents, in which case all rights and obligations of the Purchaser and Bidders previously subject to the deadline will thereafter be subject to the deadline as extended.

**16. Late Bids**

Any bid received by the Purchaser after the deadline for submission of bids prescribed by the Purchaser, will be rejected and/or returned unopened to the Bidder.

**17. Withdrawal of Bids**

1. The Bidder may withdraw its bid after the bid's submission, provided that written notice of the withdrawal is received by the Purchaser prior to the deadline prescribed for submission of bids.

**18. Opening of Bids by the Purchaser**

1. The Bidders' representatives who are present shall sign a register evidencing their attendance. In the event of the specified date for the submission and opening of bids being declared a holiday for purchaser's office, the due date for submission and opening of bids will be the following working day at the appointed time.
2. The bidders' names, bid modifications or withdrawals, bid prices, discounts, and the presence or absence of requisite bid security and such other details as the Purchaser, at its discretion, may consider appropriate, will be announced at the opening. No bid shall be rejected at bid opening, except for late bids, which shall be returned unopened to the Bidder
3. Bids that are not opened and read out at bid opening shall not be considered further for evaluation, irrespective of the circumstances.
4. The Purchaser will prepare minutes of the bid opening.

**19. Clarification of Bids**

During evaluation of bids, the Purchaser may, at its discretion, ask the Bidder for a clarification of its bid. The request for clarification and the response shall be in writing and no change in prices or substance of the bid shall be sought, offered or permitted.

**20. Preliminary Examination**

1. The Purchaser will examine the bids to determine whether they are complete, whether any computational errors have been made, whether required sureties have been furnished, whether the documents have been properly signed, and whether the bids are generally in order. Bids from Agents, without proper authorization from the manufacturer, shall be treated as non-responsive.
2. Arithmetical errors will be rectified on the following basis. If there is a discrepancy between the unit price and the total price that is obtained by multiplying the unit price and quantity, the unit price shall prevail and the total price shall be corrected. If there is a discrepancy between words and figures, the amount in words will prevail. If the supplier does not accept the correction of errors, its bid will be rejected and its bid security may be forfeited.
3. Prior to the detailed evaluation the Purchaser will determine the substantial responsiveness of each bid to the bidding documents. For purposes of these Clauses, a substantially responsive bid is one which conforms to all the terms and conditions of the bidding documents without material deviations. Deviations from or objections or reservations to critical provisions such as those concerning Performance Security, Warranty, CMC, Force Majeure, Limitation of liability, law Taxes & Duties and other important documents as per ITB, GCC, Schedule of Requirements, if there is any Special conditions in the technical specification will be deemed to be a material deviation. The Purchaser's determination of a bid's responsiveness is to be based on the contents of the bid itself without recourse to extrinsic evidence.
4. If a bid is not substantially responsive, it will be rejected by the Purchaser and may not subsequently be made responsive by the Bidder by correction of the non-conformity.
5. The Purchaser's evaluation of a bid will take into account, in addition to the bid price (Ex-factory/ex-warehouse/off-the-shelf price of the goods offered from within India, such price to include all costs as well as duties and taxes paid or payable on components and raw material incorporated or to be incorporated in the goods, and Excise duty on the finished goods, if payable) and price of incidental services, the following factors, in the manner indicated in ITB and in the Technical Specifications:
6. cost of inland transportation, insurance and other costs within India incidental to the delivery of the goods to their final

destination;

7. delivery schedule offered in the bid;

8. The cost of incidental services and Comprehensive Maintenance charges for Four years (year wise) after expiry of warranty period including spare parts to be used for CMC.

9. Other specific criteria indicated in Schedule of requirements or Technical Specification.

10. Inland Transportation, Insurance and Incidentals; Inland transportation, insurance and other incidentals for delivery of goods to the final destination

11. Goods offered from outside India, customs Duty, Insurance & freight, Clearance charges, Transportation Charges to the project site etc... The above costs will be added to the bid price for calculating lowest responsive bid.

12. If the bidder quoted in foreign currency, the same value of Indian rupee at the time of opening of the financial bid shall be taken for price comparison.

13. Determination of a bid's responsiveness should be based on the bid itself without recourse to extrinsic evidence or oral discussions.

14. The State government, through the Administrative Department and with the concurrence of Financial Department may provide purchase/price preference for goods manufactured within the state by Small, Cottage/Khadi/ Tiny enterprises/ established within the state, The preference should not be more than ten percent of the lowest quoted rate.

#### **21. Delivery Schedule:**

The Purchaser requires that the goods under the Invitation for Bids shall be delivered at the time specified in the Schedule of requirements the estimated time of arrival of the goods at the project site should be calculated for each Bid after allowing for reasonable transportation time.

#### **22. Award Criteria**

The Purchaser will award the Contract to the successful Bidder whose bid has been determined to be substantially responsive and has been determined as the lowest evaluated bid, provided further that the Bidder is determined to be qualified to perform the Contract satisfactorily.

#### **23. Purchaser's right to vary Quantities at Time of Award**

The Purchaser reserves the right at the time of Contract award to increase or decrease by 50% of the quantity of goods and services originally specified in the Schedule of Requirements without any change in unit price or other terms and conditions

#### **24. Purchaser's Right to Accept Any Bid and to Reject Any or All Bids**

The Purchaser reserves the right to accept or reject any bid or all the bids at any time of the bidding procedure without assigning any reasons

#### **25. Notification of Award**

1. Prior to the expiration of the period of bid validity, the Purchaser will notify the successful bidder in writing by registered letter or by email/telex or fax, to be confirmed in writing by registered letter, that its bid has been accepted.

2. The notification of award will constitute the formation of the Contract.

3. Upon the successful Bidder's furnishing of performance security, the Purchaser will promptly notify the name of the winning bidder at the notice board/website and will discharge its bid security

4. If, after notification of award, a Bidder wishes to ascertain the grounds on which its bid was not selected, it should address its request to the Purchaser. The Purchaser will promptly respond in writing to the unsuccessful Bidder.

5. Contract should ordinarily be awarded to the lowest evaluated bidder whose bid has been found to be responsive and who is eligible and qualified to perform the contract satisfactorily as per the terms and conditions incorporated in the corresponding bidding document. However the lowest acceptable bidder is not in a position to supply the full quantity required, the remaining quantity, as far as possible, be ordered from the next higher responsive bidder at the rates offered by the lowest responsive bidder

6. In the rate contract system, where a number of firms are brought on rate contract for the same item, negotiation as well as counter offering of rates is permitted to the bidders under specific permission of the government.

#### **26. Signing of Contract**

1. At the same time as the Purchaser notifies the successful bidder that its bid has been accepted, the Purchaser will send the bidder the Contract Form provided in the bidding documents, incorporating all agreements between the parties.

2. Within 21 days of receipt of the Contract Form, the successful bidder shall sign and date the Contract and return it to the Purchaser.

#### **27. Performance Security**

1. Within 21 days of the receipt of notification of award from the Purchaser, the successful Bidder shall furnish the performance security in accordance with the Conditions of Contract, in the Performance Security Form provided in the bidding documents or in another form acceptable to the Purchaser.

2. Failure of the successful bidder to comply with the requirement shall constitute sufficient grounds for the

annulment of the award and forfeiture of the bid security, in which event the Purchaser may make the award to the next lowest evaluated bidder or call for new bids.

3. Performance security should remain valid for a period of sixty days beyond the date of completion of all contractual obligations of the suppliers/ bidders including warranty/CMC obligations.

4. Bid security should be refunded to the successful bidder on receipt of performance security.

28. Affidavit for non convicted etc...

Enclose a Notarized affidavit that our firm not being debarred/ Blacklisted/ prosecuted by Central Govt. or any state Govt. departments for breach of agreement etc...

## **GENERAL CONDITIONS OF CONTRACT AND RESTRICTIONS**

### **1. Definitions**

In this Contract, the following terms shall be interpreted as indicated:

1. "The Contract" means the agreement entered into between the Purchaser and the Supplier, as recorded in the Contract Form signed by the parties, including all the attachments and appendices thereto and all documents incorporated by reference therein;

2. "The Contract Price" means the price payable to the Supplier under the Contract for the full and proper performance of its contractual obligations;

3. "The Goods" means all the equipment, machinery, and/or other materials which the Supplier is required to supply to the Purchaser under the Contract;

4. "Services" means services ancillary to the supply of the Goods, such as transportation and insurance, and any other incidental services, such as installation, commissioning, provision of technical assistance, training and other obligations of the Supplier covered under the Contract;

5. "GCC" means the General Conditions of Contract contained in this section.

6. "The Purchaser" means the organization purchasing the Goods

7. "The Supplier" means the individual or firm supplying the Goods and Services under this Contract.

8. "Day" means calendar day.

### **2. Country of Origin**

1. For purposes of this Clause "origin" means the place where the Goods are mined, grown or produced, or from which the Services are supplied. Goods are produced when, through manufacturing, processing or substantial and major assembling of components, a commercially recognized new product results that is substantially different in basic characteristics or in purpose or utility from its components.

2. The origin of Goods and Services is distinct from the nationality of the Supplier.

### **3. Turnover**

Certified of gross sales turnover of supplying establishment of past three years, certified by Chartered Accountant, which shall be not less than,

### **4. Sale Tax/Trade Tax**

The bidder should submit a copy of their sale tax/Trade Tax registration certificate and latest sale/Trade tax clearance certificate

### **5. Standards**

The Goods supplied under this Contract shall conform to the standards mentioned in the Technical Specifications, and, when no applicable standard is mentioned, to the authoritative standard appropriate to the Goods' country of origin and such standards shall be the latest issued by the concerned institution.

### **6. Use of Contract Documents and Information**

1. The Supplier shall not, without the Purchaser's prior written consent, disclose the Contract, or any provision thereof, or any specification, plan, drawing, pattern, sample or information furnished by or on behalf of the Purchaser in connection therewith, to any person other than a person employed by the Supplier in performance of the Contract. Disclosure to any such employed person shall be made in confidence and shall extend only so far as may be necessary for purposes of such performance.

2. Any document, other than the Contract itself, enumerated shall remain the property of the Purchaser and shall be returned (in all copies) to the Purchaser on completion of the Supplier's performance under the Contract if so required by the Purchaser.

3. The supplier shall permit the purchaser to inspect the Supplier's accounts and records relating to the performance of the Supplier and to have them audited by the officers appointed by the purchaser, if so required by the Purchaser.

### **7. Patent Rights**

The Supplier shall indemnify the Purchaser against all third-party claims of infringement of patent, trademark or industrial design rights arising from use of the Goods or any part thereof in India.

### **8. Performance Security**

1. Within 21 days after the Supplier's receipt of Notification of Award, the Supplier shall furnish Performance Security in favor of Inspector General, of Police, Police Headquarter, Dehradun to the Purchaser for an amount of 10% of the

contract value, valid up to 60 days after the date of completion of performance obligations including warranty obligations.

2. The proceeds of the performance security shall be payable to the Purchaser as compensation for any loss resulting from the Supplier's failure to complete its obligations under the Contract.

3. The Performance Security shall be denominated in Indian Rupees

4. A Bank guarantee issued by a nationalized/scheduled bank located in India in the form provided in the bidding documents or another form acceptable to the Purchaser

5. The Performance Security will be discharged by the Purchaser and returned to the Supplier not later than 60 days following the date of completion of the Supplier's performance obligations, including the warranty obligation, under the contract.

6. In the event of any correction of defects or replacement of defective material during the warranty period, the warranty for the corrected/replaced material shall be extended to a further period of 12 months and the Performance Bank Guarantee for proportionate value shall be extended 60 days over and above the extended warranty period.

7. In the event of any contract amendment, the Supplier shall, within 21 days of receipt of such amendment furnish the amendment to the Performance Security, rendering the same valid for the duration of the Contract, as amended for 60 days after the completion of performance obligations including warranty Obligations.

8. If the supplier fails to perform any duties in the contract period or any breach of contract, the performance Security shall be forfeited

### **9. Inspections and Tests**

1. The Purchaser or its representative shall have the right to inspect and/or to test the Goods to confirm their conformity to the Contract specifications at no extra cost to the Purchaser. The Purchaser shall notify the Supplier in writing in a timely manner of the identity of any representatives retained for these purposes.

2. The inspections and tests may be conducted on the premises of the Supplier or its subcontractor(s), at point of delivery and/or at the Goods final destination. If conducted on the premises of the Supplier or its subcontractor(s), all reasonable facilities and assistance, including access to drawings and production data - shall be furnished to the inspectors at no charge to the Purchaser.

3. Should any inspected or tested Goods fail to conform to the specifications, the Purchaser may reject the goods and the Supplier shall either replace the rejected Goods or make alterations necessary to meet specification requirements free of cost to the Purchaser.

4. The Purchaser's right to inspect, test and, where necessary, reject the Goods after the Goods' arrival at Project Site shall in no way be limited or waived by reason of the Goods having previously been inspected, tested and passed by the Purchaser or its representative prior to the Goods shipment.

5. The purchaser may ask the supplier to demonstrate the quoted model of equipment to confirm the quality and performance at no extra cost. If the equipments fails to meet the quality and performance, the bidder shall be disqualified

### **10. Packing**

1. The Supplier shall provide such packing of the Goods as is required to prevent their damage or deterioration during transit to their final destination as indicated in the Contract. The packing shall be sufficient to withstand, without limitation, rough handling during transit and exposure to extreme temperatures, salt and precipitation during transit and open storage. Packing case size and weights shall take into consideration, where appropriate, the remoteness of the Goods' final destination and the absence of heavy handling facilities at all points in transit.

2. The packing, marking and documentation within and outside the packages shall comply strictly with such special requirements as shall be provided for in the Contract including additional requirements, if any, and in any subsequent instructions ordered by the Purchaser.

### **11. Delivery and Documents**

Delivery of the Goods shall be made by the Supplier in accordance with the terms specified by the Purchaser in the Notification of Award. The details of shipping and/or other documents to be furnished by the supplier

### **12. Insurance**

1. The Goods supplied under the Contract shall be fully insured against loss or damage incidental to manufacture or acquisition, transportation, storage and delivery.

2. For delivery of goods at site, the insurance shall be obtained by the Supplier in an amount equal to 110% of the value of the goods from "warehouse to warehouse" (final destinations) on "All Risks" basis including War Risks and Strikes.

### **13. Transportation**

Where the Supplier is required under the Contract to transport the Goods to a specified place of destination within India defined as Project site, transport to such place of destination in India including insurance, as shall be specified in the Contract, shall be arranged by the Supplier, and the related cost shall be included in the Contract Price.

### **14. Incidental Services**

The supplier may be required to provide any or all of the following services, including additional services.

- (a) Performance or supervision of the on-site assembly and/or start-up of the supplied Goods;
- (b) Furnishing of tools required for assembly and/or maintenance of the supplied Goods;
- (c) Furnishing of detailed operations and maintenance manual for each appropriate unit of supplied Goods;
- (d) performance or supervision or maintenance and/or repair of the supplied Goods, for a period of time agreed by the parties, provided that this service shall not relieve the Supplier of any warranty obligations under this Contract; and
- (e) Training of the Purchaser's personnel, at the Supplier's plant and/or on-site, in assembly, start-up, operation, maintenance and/or repair of the supplied Goods. Furnishing of detailed operations and maintenance manual for each appropriate unit of supplied Goods Original Equipment Manufacturer (OEM) should ensure that in house biomedical staff of the consignee should be able to rectify all kinds of problems; for which it is mandatory for OEM /Supplier to impart Factory / workshop training and technical know how to biomedical engineering staff for preventive maintenance, servicing, faults diagnostics.

#### **15. Spare Parts**

1. The spare parts of the quoted model should be available for minimum 10years from the date of successful installation

#### **16. Warranty and Comprehensive Maintenance Contract (CMC)**

1. The Supplier warrants that the Goods supplied under this Contract are new, unused, of the most recent or current models and those they incorporate all recent improvements in design and materials unless provided otherwise in the Contract. The Supplier further warrants that all Goods supplied under this Contract shall have no defect arising from design, materials or workmanship (except when the design and/or material is required by the Purchaser's Specifications) or from any act or omission of the Supplier, that may develop under normal use of the supplied Goods in the conditions prevailing in the country of final destination.
2. This warranty shall remain valid for 36 months after the Goods or any portion thereof as the case may be, have been delivered to and accepted at the final destination indicated in the Contract, or for 48 months after the date of shipment from the place of loading whichever period concludes earlier.
3. The Purchaser shall promptly notify the Supplier in writing of any claims arising under this warranty.
4. In the time of warranty and CMC period the supplier shall to perform minimum three year Preventive Maintenance Service of the equipments at the sites and produce report to the facility in charge.
5. Upon receipt of such notice, the Supplier shall, within the period specified in the contract and with all reasonable speed, repair or replace the defective Goods or parts thereof, without cost to the Purchaser other than, where Applicable, the cost of inland delivery of the repaired or replaced Goods or parts from ex-works or ex-factory or exshowroom to the final destination. If the Supplier, having been notified, fails to remedy the defect(s) within the period specified, the Purchaser may proceed to take such remedial action as may be necessary, at the Supplier's risk and expense and without prejudice to any other rights which the Purchaser may have against the Supplier under the Contract
6. After warranty period, Comprehensive maintenance and repairs of the entire system including supply of spares, labour etc., for next Four years be done by the supplier. The supplier shall quote rate for four year comprehensive maintenance separately (year wise) .The bid evaluation will take into account the bid price quoted & comprehensive annual maintenance Charges for five years after warranty.
7. During Comprehensive contract Period the Unit must function in totality for 325 days in a year. In case of noncompliance of the above a financial penalty at the rate of 0.75% of the CC value per day shall be imposed and equivalent amount shall be deducted from the CMC value. During Comprehensive Maintenance Period the unit must be made functional within 7 working days (including response time) from the time a defect is reported to the bidder. In case, a replacement of defective item / Unit needs more than 7 working days, as an interim solution the bidder must take available a service unit / part for complete functioning of the Unit within the same specified time frame as mentioned above. However, the defective item must be replaced within 30days.
8. The authorized supplier also responsible for warranty and CMC services.

#### **17. Payment**

Payment for Goods and Services shall be made as follows:

1. The Supplier's request(s) for payment shall be made to the Purchaser in writing, accompanied by an invoice in triplicate describing, as appropriate, the Goods delivered and the Services performed, and upon fulfillment of other obligations stipulated in the contract.
2. On Delivery: Ninety percent of the contract price shall be paid within sixty (60) days on receipt of Goods and upon submission of the documents specified below, Upon delivery of the Goods, the supplier shall notify the purchaser and the insurance company by email/telex/fax/email, the full details of the shipment including contract number, date, description of goods, quantity, name of the consignee etc. The supplier shall mail the following documents to the purchaser with a copy to the insurance company:
  - (i) Three Copies of the Supplier invoice showing contract number, goods' description, quantity, and unit price, total amount;
  - (ii) Acknowledgment of receipt of goods from the consignee(s);

- (iii) Three Copies of packing list identifying the contents of each package;
  - (iv) Insurance Certificate;
  - (v) Manufacturer's/Supplier's warranty certificate;
  - (vi) Inspection Certificate, If any issued by the nominated inspection agency, and the Supplier's factory inspection report; and
  - (vii) Certificate of Origin.
3. On Final Acceptance: the remaining ten percent of the Contract Price shall be paid to the supplier within 30 days after the date of the consignees acceptance certificate (the given Performa) issued by the Purchaser's representative for the respective delivery. This acceptance certificate will issue only after the completion of successful installation and training of the equipment
4. Where payments are to be effected through Letter of Credit (LC), the same shall be subject to the latest Uniform Customs and Practice for Documentary Credit, of the International Chamber of Commerce;
5. Where payments are to be effected through Letter of Credit (LC) the purchaser shall release only 90% of the contract value through LC balance 10 percent shall be paid only after completing the successful installation and training of the equipment
6. The LC will be confirmed at Supplier's cost if requested specifically by the Supplier;
7. If LC is required to be extended/ reinstated for reasons not attributable to the Purchaser, the charges thereof shall be to the Supplier's account.
8. Payment of Comprehensive Maintenance Charges- the Comprehensive Maintenance & Repair Cost (after warranty period) shall be paid in equal yearly installments after receipt of claim at the start of each year, after completion of warranty period.
9. Obligations of the previous year, at the rates quoted in the price schedule, on the receipt of Bank guarantee for 2.5% of the cost of equipment (excluding CMC cost) in the form provided in the bidding documents valid for 60 months from the date of completion of warranty period. (The Bank Guarantee submitted towards performance guarantee will be released only after receipt of the above).

### **18. Prices**

Prices charged by the Supplier for Goods delivered and Services performed under the Contract shall not vary from the prices quoted by the Supplier in its bid, with the exception of any price adjustments authorized or in the Purchaser's request for bid validity extension, as the case may be.

### **19. Change Orders**

The Purchaser may at any time, by written order given to the Supplier, make changes within the general scope of the Contract in any one or more of the following:

- (a) Drawings, designs, or specifications, where Goods to be furnished under the Contract are to be specifically manufactured for the Purchaser;
- (b) The method of shipping or packing;
- (c) The place of delivery; and/or
- (d) The Services to be provided by the Supplier.

If any such change causes an increase or decrease in the cost of, or the time required for, the Supplier's performance of any provisions under the Contract, an equitable adjustment shall be made in the Contract Price or delivery schedule, or both, and the Contract shall accordingly be amended. Any claims by the Supplier for adjustment under this clause must be asserted within thirty (30) days from the date of the Supplier's receipt of the Purchaser's change order.

### **20. Contract Amendments**

No variation in or modification of the terms of the Contract shall be made except by written amendment signed by the parties.

### **21. Assignment**

The Supplier shall not assign, in whole or in part, its obligations to perform under the Contract, except with the Purchaser's prior written consent.

### **22. Subcontracts (for Turn Key projects only)**

The Supplier shall notify the Purchaser in writing of all subcontracts awarded under this Contract if not already specified in the bid. Such notification, in his original bid or later, shall not relieve the Supplier from any liability or obligation under the Contract.

### **23. Delays in the Supplier's Performance**

1. Delivery of the Goods and performance of the Services shall be made by the Supplier in accordance with the time schedule specified by the Purchaser in the Schedule of Requirements.
2. If at any time during performance of the Contract, the Supplier or its sub-contractor(s) should encounter conditions impeding timely delivery of the Goods and performance of Services, the Supplier shall promptly notify the Purchaser in writing of the fact of the delay, its likely duration and its cause(s). As soon as practicable after receipt of the Supplier's notice, the Purchaser shall evaluate the situation and may, at its discretion, extend the Supplier's time for performance with or without liquidated damages, in which case the extension shall be ratified by the parties by amendment of the Contract.

### **24. Liquidated Damages**

If the Supplier fails to deliver any or all of the Goods or to perform the Services within the period(s) specified in the Contract, the Purchaser shall, without prejudice to its other remedies under the Contract, deduct 0.5% per week and the maximum deduction is 10% of the contract price from the Contract Price, as liquidated damages, of the delivered price of the delayed Goods or

nperformed Services for each week or part thereof of delay until actual delivery or performance,. Once the maximum is reached, the Purchaser may consider termination of the Contract.

#### **25. Termination for Default**

The Purchaser may, without prejudice to any other remedy for breach of contract, by written notice of default sent to the Supplier, terminate the Contract in whole or part:

- (a) if the Supplier fails to deliver any or all of the Goods within the period(s) specified in the Contract, or within any extension thereof granted by the Purchaser ; or
- (b) if the Supplier fails to perform any other obligation(s) under the Contract.
- (c) if the Supplier, in the judgment of the Purchaser has engaged in fraud and corruption, in competing for or in executing the Contract.

In the event the Purchaser terminates the Contract in whole or in part, the Purchaser may procure, upon such terms and in such manner as it deems appropriate, Goods or Services similar to those undelivered, and the Supplier shall be liable to the Purchaser for any excess costs for such similar Goods or Services. However, the Supplier shall continue the performance of the Contract to the extent not terminated.

#### **26. Force Majeure**

1. The Supplier shall not be liable for forfeiture of its performance security, liquidated damages or termination for default, if and to the extent that, its delay in performance or other failure to perform its obligations under the Contract is the result of an event of Force Majeure.
2. For purposes of this Clause, "Force Majeure" means an event beyond the control of the Supplier and not involving the Supplier's fault or negligence and not foreseeable. Such events may include, but are not limited to, acts of the Purchaser either in its sovereign or contractual capacity, wars or revolutions, fires, floods, epidemics, quarantine restrictions and freight embargoes.
3. If a Force Majeure situation arises, the Supplier shall promptly notify the Purchaser in writing of such conditions and the cause thereof. Unless otherwise directed by the Purchaser in writing, the Supplier shall continue to perform its obligations under the Contract as far as is reasonably practical, and shall seek all reasonable alternative means for performance not prevented by the Force Majeure event.

#### **27. Termination for Insolvency**

The Purchaser may at any time terminate the Contract by giving written notice to the Supplier, if the Supplier becomes bankrupt or otherwise insolvent. In this event, termination will be without compensation to the Supplier, provided that such termination will not prejudice or affect any right of action or remedy which has accrued or will accrue thereafter to the Purchaser.

#### **28. Termination for Convenience**

1. The Purchaser, by written notice sent to the Supplier, may terminate the Contract, in whole or in part, at any time for its convenience. The notice of termination shall specify that termination is for the Purchaser's convenience, the extent to which performance of the Supplier under the Contract is terminated, and the date upon which such termination becomes effective.
2. The Goods that are complete and ready for shipment within 30 days after the Supplier's receipt of notice of termination shall be accepted by the Purchaser at the Contract terms and prices. For the remaining Goods, the Purchaser may elect:
  - (a) to have any portion completed and delivered at the Contract terms and prices; and/or
  - (b) to cancel the remainder and pay to the Supplier an agreed amount for partially completed Goods and for materials and parts previously procured by the Supplier.

#### **29. Settlement of Disputes**

1. The Purchaser and the supplier shall make every effort to resolve amicably by direct informal negotiation any disagreement or dispute arising between them under or in connection with the Contract.
2. If, after thirty (30) days, the parties have failed to resolve their dispute or difference by such mutual consultation, then either the Purchaser or the Supplier may give notice to the other party of its intention to commence arbitration, as hereinafter provided, as to the matter in dispute, and no arbitration in respect of this matter may be commenced unless such notice is given.
3. Any dispute or difference in respect of which a notice of intention to commence arbitration has been given in accordance with this Clause shall be finally settled by arbitration. Arbitration may be commenced prior to or after delivery of the Goods under the Contract.
4. Arbitration proceedings shall be conducted in accordance with the rules of procedure
5. Notwithstanding any reference to arbitration herein, the parties shall continue to perform their respective obligations under the Contract unless they otherwise agree; and the Purchaser shall pay the Supplier any monies due the Supplier.
6. In case of Dispute or difference arising between the Purchaser and a supplier relating to any matter arising out of or connected with this agreement, such disputes or difference shall be settled in accordance with the Arbitration and Conciliation Act, 1996. The arbitral tribunal shall consist of 3 arbitrators one each to be appointed by the Purchaser and the Supplier. The third Arbitrator shall be chosen by the two Arbitrators so appointed by the Parties and shall act as presiding arbitrator. In case of failure of the two arbitrators appointed by the parties to reach upon a consensus within a period of 30 days from the appointment of the arbitrator appointed subsequently, the Presiding Arbitrator shall be appointed by the Indian Council of Arbitration/President of the Institution of Engineers (India)/The International Centre for Alternative Dispute Resolution (India).
7. In the case of a dispute with a Foreign Supplier, the dispute shall be settled in accordance with provisions of UNCITRAL

(United Nations Commission on International Trade Law) Arbitration Rules. The Arbitral Tribunal shall consist of three Arbitrators one each to be appointed by the Purchaser and the Supplier. The third Arbitrator shall be chosen by the two Arbitrators so appointed by the Parties, and shall act as presiding arbitrator. In case of failure of the two arbitrators appointed by the parties to reach upon a consensus within a period of 30 days from the appointment of the arbitrator appointed subsequently, the Presiding Arbitrator shall be appointed by the Indian Council of Arbitration/President of the Institution of Engineers (India)/The International Centre of Alternative Dispute Resolution (India).

8. If one of the parties fails to appoint its arbitrator in pursuance of sub-clause above, within 30 days after receipt of the notice of the appointment of its arbitrator by the other party, then the Indian Council of Arbitration/President of the Institution of Engineers (India)/The International Centre for Alternative Dispute Resolution (India), both in cases of the Foreign supplier as well as Indian supplier, shall appoint the arbitrator. A certified copy of the order of the Indian Council of Arbitration/President of the Institution of Engineers (India)/The International Centre for Alternative Disputes Resolution (India), making such an appointment shall be furnished to each of the parties.

9. Arbitration proceedings shall be held at Dehradun, India, and the language of the arbitration proceedings and that of all documents and communications between the parties shall be English.

10. The decision of the majority of arbitrators shall be final and binding upon both parties. The cost and expenses of Arbitration proceedings will be paid as determined by the arbitral tribunal. However, the expenses incurred by each party in connection with the preparation, presentation etc. of its proceedings as also the fees and expenses paid to the arbitrator appointed by such party or on its behalf shall be borne by each party itself.

### **30. Limitation of Liability**

Except in cases of criminal negligence or willful misconduct, and in the case of infringement

(a) the Supplier shall not be liable to the Purchaser, whether in contract, tort, or otherwise, for any indirect or consequential loss or damage, loss of use, loss of production, or loss of profits or interest costs, provided that this exclusion shall not apply to any obligation of the Supplier to pay liquidated damages to the Purchaser; and

(b) The aggregate liability of the Supplier to the Purchaser, whether under the Contract, in tort or otherwise, shall not exceed the total Contract Price, provided that this limitation shall not apply to the cost of repairing or replacing defective equipment

### **31. Governing Language**

The contract shall be written in English language version of the Contract shall govern its interpretation. All correspondence and other documents pertaining to the Contract which are exchanged by the parties shall be written in the same language.

### **32. Applicable Law**

The Contract shall be interpreted in accordance with the laws of the Union of India.

### **33. Taxes and Duties**

Suppliers shall be entirely responsible for all taxes, duties, license fees, octroi, road permits, etc., incurred until delivery of the contracted Goods to the Purchaser.

### **34. Fraud and Corruption**

The purchaser requires that the Bidders, Suppliers, Contractors, and Consultants under this contracts, observe the highest standard of ethics during the procurement and execution of such contracts. In pursuit of this policy, the purchaser: defines, for the purposes of this provision, the terms set forth below as follows:

(i) "corrupt practice" means the offering, giving, receiving, or soliciting, directly or indirectly, of anything of value to influence the action of a public official in the procurement process or in contract execution;

(ii) "fraudulent practice" means a misrepresentation or omission of facts in order to influence a procurement process or the execution of a contract;

(iii) "collusive practice" means a scheme or arrangement between two or more Bidders, with or without the knowledge of the borrower, designed to establish bid prices at artificial, non competitive levels; and

(iv) "coercive practice" means harming or threatening to harm, directly or indirectly, persons or their property to influence their participation in the procurement process or affect the execution of a contract; purchaser have the right to inspect their accounts and records and other documents relating to the bid submission and contract performance and to have them audited by auditors appointed by the purchaser. If the supplier firm founds faulty purchaser can take appropriate action against the supplying firm

### **35. Miscellaneous Conditions**

1. If the supplier firm founds faulty (any type of breach of contract) purchaser can take appropriate action against the supplying firm including "blacklisting of the firm".

2. Goods to be installed within 15 days from date of supply. Pre – requisites for Installation should be clearly mentioned at the time of submitting the bid.

3. Any conditions specified as special conditions of the contract (SCC) with the technical specification, the SCC shall overrule the GCC in the particular matter.

4. Installation should include minor Civil Works, Electrical Works & Mechanical Fabrication Works. Consignee shall provide the required space/room and electrical supply.

5. Following should be compulsory supplied to each of the consignee(Note- all written material should be preferably

in both English and local language i.e. Hindi )

6. All necessary attachments required to run the System / Unit. Installation manual, Operative manual, Day to day maintenance manual / chart, Dos and Don'ts manual/chart.

7. Mention if the unit can be used Off Line UPS, on line UPS, Petrol Generator, or Diesel Generator.

8. All the judiciary procedures against this tender shall be under the Jurisdiction of Dehradun (Uttarakhand)

9. One additional copies of all the above along with one copies of service Manual (complete with Preventive maintenance, troubleshooting, fault finding, repairs manual, comprehensive & authentic circuit Diagrams, etc.) should be submitted to Deputy Inspector General Of Police (P/T) , jorhi gaon road ,Jakhan, Dehradun for necessary verification and certification of the same.

10. System / Unit models having minimum life span with good functional working of minimum 10 years should only be quoted.

### **BID FORM**

Date :.....

Bid.Ref No :.....

TO: (Name and address of purchaser)

Sir/Madam,

Having examined the Bidding Documents and technical specifications and we offer as..... (Describe Manufacturer or Manufacturer's Authorized Representative) to supply and deliver the goods..... (Description of Goods and Services) in conformity with the said bidding documents

We undertake, if our bid is accepted, to deliver the goods in accordance with the delivery schedule specified in the Schedule of Requirements.

If our bid is accepted, we will obtain the guarantee of a bank in a sum equivalent to 10% of the Contract Price for the due performance of the Contract, in the form prescribed by the Purchaser.

We agree to abide by this bid for the Bid validity period mentioned in the bid document and it shall remain binding upon us and may be accepted at any time before the expiration of that period.

We, the authorized supplier (In the case of goods supplied by authorized supplier not by the OEM), also equally responsible for the Warranty and CMC period of the quoted equipments

Until a formal contract is prepared and executed, this bid, together with your written acceptance thereof and your notification of award shall constitute a binding Contract between us.

We undertake that, in competing for (and, if the award is made to us, in executing) the above contract, we will strictly observe the laws against fraud and corruption in force in India namely "Prevention of Corruption Act 1988".

We understand that you are not bound to accept the lowest or any bid you may receive.

The agreement shall be governed and construed in accordance with the laws of India and we agree to submit to the exclusive jurisdiction of the Indian Courts at Dehradun/Uttarakhand

I do here by solemnly affirm that all the information furnished with the offer is true and nothing material is concealed

Dated this ..... day of ..... 20--

\_\_\_\_\_  
(Signature) (in the capacity of)

Duly authorized to sign Bid for and on behalf of \_\_\_\_\_

**BID SECURITY FORM**

Whereas .....<sup>1</sup> (hereinafter called “the Bidder”) has submitted its bid dated ..... (date of submission of bid) for the supply of ..... (name and/or description of the goods) (hereinafter called “the Bid”).

KNOW ALL PEOPLE by these presents that WE ..... (name of bank) of ..... (name of country), having our registered office at ..... (address of bank) (hereinafter called “the Bank”), are bound unto ..... (name of Purchaser) (hereinafter called “the Purchaser”) in the sum of \_\_\_\_\_ for which payment well and truly to be made to the said Purchaser, the Bank binds itself, its successors, and assigns by these presents.

Sealed with the Common Seal of the said Bank this \_\_\_\_ day of \_\_\_\_\_ 20\_\_.

THE CONDITIONS of this obligation are:

1. If the Bidder

- (a) Withdraws its Bid during the period of bid validity specified by the Bidder on the Bid Form; or
- (b) Does not accept the correction of errors in accordance with the ITB/GCC/; or

2. If the Bidder, having been notified of the acceptance of its bid by the Purchaser during the period of bid validity:

- (a) Fails or refuses to execute the Contract Form if required; or
- (b) Fails or refuses to furnish the performance security, in accordance with the Instruction to Bidders;

we undertake to pay the Purchaser up to the above amount upon receipt of its first written demand, without the Purchaser having to substantiate its demand, provided that in its demand the Purchaser will note that the amount claimed by it is due to it, owing to the occurrence of one or both of the two conditions, specifying the occurred condition or conditions.

This guarantee will remain in force up to and including forty five (45) days after the period of the bid validity, and any demand in respect thereof should reach the Bank not later than the above date.

.....

(Signature of the Bank)

\_\_\_\_\_  
<sup>1</sup> Name of Bidder

**CONTRACT FORM**

THIS AGREEMENT made the .....day of....., 20... Between..... (Name of purchaser) of ..... (Country of Purchaser) (Hereinafter called "the Purchaser") of the one part and ..... (Name of Supplier) of ..... (City and Country of Supplier) (Hereinafter called "the Supplier") of the other part : WHEREAS the Purchaser is desirous that certain Goods and ancillary services viz., ..... (Brief Description of Goods and Services) and has accepted a bid by the Supplier for the supply of those goods and services in the sum of ..... (Contract Price in Words and Figures) (Hereinafter called "the Contract Price").

NOW THIS AGREEMENT WITNESSETH AS FOLLOWS:

1. In this Agreement words and expressions shall have the same meanings as are respectively assigned to them in the Conditions of Contract referred to.
  2. The following documents shall be deemed to form and be read and construed as part of this Agreement, viz.:
    - (a) The Bid Form and the Price Schedule submitted by the Bidder;
    - (b) The Schedule of Requirements;
    - (c) The Technical Specifications;
    - (d) The General Conditions of Contract and restrictions;
    - (e) The Special Conditions of Contract; and
    - (f) The Purchaser's Notification of Award.
  3. In consideration of the payments to be made by the Purchaser to the Supplier as hereinafter mentioned, the Supplier hereby covenants with the Purchaser to provide the goods and services and to remedy defects therein in conformity in all respects with the provisions of the Contract.
  4. The Purchaser hereby covenants to pay the Supplier in consideration of the provision of the goods and services and the remedying of defects therein, the Contract Price or such other sum as may become payable under the provisions of the Contract at the times and in the manner prescribed by the Contract.
- Brief particulars of the goods and services which shall be supplied/ provided by the Supplier are as under:

SL. NO.	BRIEF DESCRIPTION OF GOODS & SERVICES	QUANTITY TO BE SUPPLIED	UNIT PRICE	TOTAL DELIVERY PRICE	TERMS
---------	---------------------------------------	-------------------------	------------	----------------------	-------

**TOTAL VALUE:**

**DELIVERY SCHEDULE:**

**IN WITNESS** whereof the parties hereto have caused this Agreement to be executed in accordance with their respective laws the day and year first above written.

Signed, Sealed and Delivered by the  
said ..... (For the Purchaser)  
in the presence of:.....

Signed, Sealed and Delivered by the  
said ..... (For the Supplier)  
in the presence of:.....

**PERFORMANCE SECURITY FORM**

To: (Name of Purchaser)

WHEREAS ..... (Name of Supplier) hereinafter called "the Supplier" has undertaken , in pursuance of Contract No..... dated,..... 20... to supply.....

.....(Description of Goods and Services) hereinafter called "the Contract".

AND WHEREAS it has been stipulated by you in the said Contract that the Supplier shall furnish you with a Bank Guarantee by a recognized bank for the sum specified therein as security for compliance with the Supplier's performance obligations in accordance with the Contract.

AND WHEREAS we have agreed to give the Supplier a Guarantee:

THEREFORE WE hereby affirm that we are Guarantors and responsible to you, on behalf of the Supplier, up to a total of ..... (Amount of the Guarantee in Words and Figures) and we undertake to pay you, upon your first written demand declaring the Supplier to be in default under the Contract and without cavil or argument, any sum or sums within the limit of ..... (Amount of Guarantee) as aforesaid, without your needing to prove or to show grounds or reasons for your demand or the sum specified therein.

This guarantee is valid until the .....day of.....20.....

Signature and Seal of Guarantors

.....  
.....  
.....

Date.....20....

Address:.....

.....  
.....

**PROFORMA FOR PERFORMANCE STATEMENT IN INDIA (For a period of last three years)**

Bid No. \_\_\_\_\_ Date of opening \_\_\_\_\_ Time \_\_\_\_\_ Hours

Name of the Firm \_\_\_\_\_

Date of completion of delivery Order Placed by (Full address of Purchaser with phone and fax number)	Order No. and Date	Description and quantity of ordered items	Value of Order	Date of completion of delivery		Remarks indicating reasons for late delivery, if any	Have the items been supplied satisfactorily and working properly. (Attach the certificates from the Purchaser/ Consignee with contact address, Land line telephone Number, Fax Number and mobile number)
				As per Contract	Actual		
1	2	3	4	5	6	7	8

**Signature and seal of the Bidder** \_\_\_\_\_

\_\_\_\_\_

**Countersigned by Chartered Accountant**

**(Signature, Seal and full address of the CA)**

**MANUFACTURERS' AUTHORIZATION FORM**

(From the Original Equipment Manufacturer)

Dated-.....

To  
Director General of Police  
12 A, Subhash Road  
Uttarakhand Police Headquarter  
Dehradun 248001  
(Uttarakhand )

Dear Sir/Madam:

**Bid Reference No.**

We who are established and reputable manufacturers of .....(name and description of goods offered) having factories at (address of factory) do hereby authorize M/s (Name and address of Agent) to submit a bid, and sign the contract with you for the goods manufactured by us against the above Bid Ref. No.....No company or firm or individual other than M/s are authorized to bid, and conclude the contract for the above goods manufactured by us, against this specific Tender. We hereby extend our full guarantee and warranty as per the bid document of the General Conditions of Contract and the Special conditions of Contract for the goods and services offered for supply by the above firm against this Tender.

Yours faithfully,  
(Name)

(Name of manufacturers)

**Note:** This letter of authority should be on the letterhead of the manufacturer with full address, phone number, email, and website address, and should be signed by a person competent and having the power of attorney to legally bind the manufacturer. It should be included by the Bidder in its bid.

### **Consignee's Acceptance Certificate**

(To be given by consignee's authorized representative)

The following stores have been received in good condition:

- 1. Name of item supplied :**
- 2. Product No. :**
- 3. Name of Supplier/ Manufacturer :**
- 4. No. of Units supplied :**
- 5. Place of destination :**
- 6. Name and address of consignee :**  
**Along with Tel. No. & Fax No.**
- 7. Date of Receipt by Consignee :**
- 8. Date of Satisfactory Installation. :**
- 9. Signature of Authorized Representative :**  
**of Consignee with date**
- 10. Name & Designation of the authorized :**  
**Representative**
- 11. Seal of consignee :**

**FORMAT FOR BANK GUARANTEE AGAINST COMPREHENSIVE MAINTAINENCE CONTRACT**

(To be stamped in accordance with Stamp Act if any, of the Country of the Issuing Bank)

Bank Guarantee No: \_\_\_\_\_ Date: \_\_\_\_\_

To.....(Name of the Purchaser)

Whereas .....(Name of the Purchaser) hereinafter called “the supplier” has undertaken, in pursuance of Contract No..... dated .....20..... To Supply

..... (Description of Goods and Services) hereinafter called “the Contract”.

AND WHEREAS it has been stipulated by you in the said contract that the Supplier shall furnish you with a Bank Guarantee by a recognised Bank for the sum specified therein as security for compliance with the Supplier’s performance obligations under the contract for Annual Maintainence and Repairs of the entire system including cost of spares after warranty period for next five years.

AND WHEREAS we have agreed to give the Supplier a Guarantee.

THEREFORE WE hereby affirm that we are Guarantors and responsible to you on behalf of the Supplier up to a total of Rs.....(Amount of Guarantee in words and figures) being 2.5% of the total cost of equipment and we undertake to pay you, upon your first written demand decalring the Supplier to be in default under the contract and without cavil argument, any sum or sums within the limit of Rs.....(Amount of Guarantee) as aforesaid, woithout your needing to prove or to show grounds or reasons for your demand or the sum specified therein.

This Guarantee is valid until.....day of .....20.....

Signature and Seal of Guarantors.

.....  
.....  
.....

Date: .....20.....

NOTE:

SUPPLIERS SHOULD ENSURE THAT SEAL AND CODE No. OF THE SIGNATORY IS PUT BY THE BANKERS, BEFORE SUBMISSION OF THE BANK GUARANTEES.

**PRICE SCHEDULE (Quoting in Indian National Rupees (INR))**

1	2	3	4	5	6					7	8
					Quoted Unit Rate in Rupees Unit					Price (in Rs.)	Total Price (in Rs.)
S.No	Description of Goods	Name of Manufacturing firm	Quantity in Numbers	Rates Exclusive of all taxes and duties	VAT	CST/ Excise Duty	SST	Inland Transportation, Insurance & other local costs incidental to delivery	Incidental services, if any	a+b +c+d +e+f	4x7
				a	b	c	d	e	f		

Gross Total Cost Rs.-----

We agree to supply the above goods in accordance with the technical specifications for a total Contract Price of Rs. -----  
 ----- (amount in figures)[Rs. ----- (amount in words) within the period specified in the invitation of bid.(Schedule of Requirements)

**Note:** Supplier shall furnish the price details in this format, any deviation from this format may cause for rejection of the price bid. In case of discrepancy between unit price and total price, the unit price shall prevail. For all supplies under the "Rate contract" the bidder needs to deliver all the quoted goods to all/any destinations (required) in the state of Uttarakhand in the quoted unit price. Government of Uttarakhand, Dehradun shall issue form 'D' for concessional Central Sales Tax wherever Applicable. Charges for Comprehensive Maintenance Charges for 4 (four) Years after 3 (Three) Years Warranty should be quoted in the annexed **Price Schedule**.

Place:

Date:

Name : \_\_\_\_\_

Business Address: \_\_\_\_\_

Signature of Bidder \_\_\_\_\_

### Price Schedule for Goods Offered from Abroad

Name of Bidder .

Bid Ref. Number .

<u>1</u>	<u>2</u>	<u>3</u>	<u>4</u>	<u>5</u>				<u>6</u>	<u>7</u>	<u>8</u>
S.No	Product Details	Name of the Manufacturer and Country Of Origin	Ex-Showroom Price	Unit prices				Unit Cost a+b+c+d+e	Qty. Offered	Total Bid Price 6 X 7
				[a] CIF Landed	[b] Inland Transportation Insurance & other local costs incidental to delivery at the consignees site	[c] Customs duty if applicable	[d] Any other charges	[e] Indian agent's commission (If Applicable)		

**Total Bid Price –**

**Currency-**

**In Figure-**

**In Words-**

**Signature of the bidder-**

**Name of the bidder-**

**Business Address-**

- \* Supplier shall furnish the price details in this format, any deviation from this format may cause for rejection of the price bid
- \* All the Demurrage charges shall be the responsibility of the bidder.
- \* Bidder should quote all the prices up to the consignees site
- \* Charges for Comprehensive Maintenance Charges for 4 (four) Years after 3 (Three) Years Warranty should be quoted in the annexed Price Schedule in Indian Rupees.
- \* In case of discrepancy between unit price and total price, the unit price shall prevail.

**Annexed Price Schedule**  
**PRICE SCHEDULE FOR COMPREHENSIVE MAINTENANCE AND REPAIR CHARGES AFTER**  
**WARRANTY PERIOD**

A	B	C	D
Item No.	Item Description	Quantity in No.	Comprehensive Annual Maintenance & Repair charge (including spares) for each Unit Price in Rupees
1	Year 1 One	One	Under Warranty
	Year 2 One	One	Under Warranty
	Year 3 One	One	Under Warranty
	Year 4 One	One	
	Year 5 One	One	
	Year 6 One	One	
	Year 7 One	One	
	Year 8 One	One	
	Total		

**Note-**

1. This should be given item wise, year wise with total in column D.
2. In case of discrepancy between unit price and total prices, the unit price shall prevail.

Signature of Bidder.....  
Name of Bidder.....  
Business Address.....

Place-  
Date

## Chapter 8<sup>th</sup>

### **CHECK LIST FOR TENDERERS/BIDDERS**

Tenderers are requested in their own interest to check the following before they submit their bids: -

1	PAN Account No. of the Firm.	Yes	No	Page no.
2	Valid Sales Tax registration certificate as where Firm situated	Yes	No	Page no.
3	Terms of Delivery at F.O.R. Police Station Risikesh	Yes	No	Page no.
4	Has the shortest delivery period been indicated	Yes	No	Page no.
5	Have you agreed the validity of offer	Yes	No	Page no.
6	Confirmation about availability of testing facilities as stipulated in the specifications / tender enquiry?	Yes	No	Page no.
7	Acceptance of all terms and conditions of Tender Enquiry including payment terms, Guarantee/ Warranty	Yes	No	Page no.
8	Attached Duly signed copy of tender document.	Yes	No	Page no.
9	Have you enclosed the following documents?			Page no.
(i)	Technical compliance statement in the prescribed format with the details of deviations?	Yes	No	Page no.
(ii)	Photocopy of OEM Registration Certificate.	Yes	No	Page no.
(iii)	Past Performance ( order copies of same supplies)	Yes	No	Page no.
(iii)	Number of Demand Draft/F.D.R			
	a. Tender Fee Rs. 265/-	Cash	Draft	Page no.
	b. Earnest Money-Rs.16000/- (Validity not less than six months)	-	F.D.R	Page no.
10	Whether installation and commissioning confirmed? (if applicable)	Yes	No	Page no.
11	I/We have read term & conditions and agree it.	Yes	No	Page no.

***PLEASE NOTE THAT NON-SUBMISSION OF THE ABOVE INFORMATION/DOCUMENTS MAKES THE OFFER LIABLE TO BE IGNORED WITHOUT ANY FURTHER REFERENCE TO THE BIDDER.***

Signature of Authorized persons of the Firm

Stamps of Firms